

FOOD SERVICE EQUIPMENT



„Enjoy the new APS products 2021/22!“



Reinhold Pott
managing director

Johannes Becker
managing director

family-run company
— since 1933 —

Als inhabergeführtes Unternehmen in der 4. Generation legt APS viel Wert auf Kontinuität, Innovation und Vertrauen.

As a family-run company in the 4th generation, we value continuity, innovation and trust.

Como empresa familiar administrada por la 4ª generación ponemos mucho énfasis en la continuidad, la innovación y la confianza.

En tant qu'entreprise familiale gérée par la 4ème génération, nous partageons nos valeurs en termes de continuité, d'innovation et de confiance.

APS - Mehrwert:
Inspiration & Service

APS - your added value:
inspiration and service

APS - tu valor añadido:
inspiración y servicio

APS - votre valeur ajoutée:
inspiration et service

GERMAN
BRAND



APS head office | Sundern Germany



APS production | Made in Germany | stainless steel trays



Assheuer + Pott GmbH & Co. KG
Talweg 11 | 59846 Sundern
Germany

Phone: +49 (0) 29 33 / 97 35 - 0
E-Mail: info@aps-germany.de
aps-germany.de

buffet | tabletop | bar



Keep in touch [aps_germany](https://www.instagram.com/aps_germany)



Visit our website!

NEW SUPER DOME



Frischhalte-Haube „SUPER DOME“

cover
campana
cloche



schwere, glasklare Qualität
stable, crystal clear quality
muy resistente y transparencia cristalina
haute résistance et transparence

	Ø cm	↑ cm
06525	30	40

passende Servier- Tortenplatten / suitable cake stands / porta pasteles compatibles / présentoirs à gâteaux compatibles

	Ø cm	↑ cm	fits to	Farbe / Colour
85051	30,5	9,0	06525	
85052	30,5	17,0	06525	
00468	31,0	3,5	06525	
85112	32,0	3,5	06525	
33294	33,0	8,0	06525	
33295	33,0	16,0	06525	

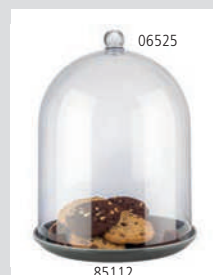

Servierbeispiel
presentation example

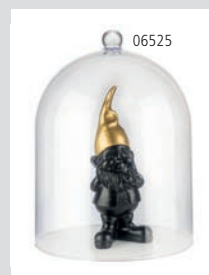

Präsentationsmöglichkeiten
presentation examples

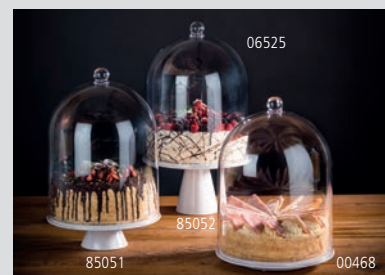



NEW

Thekendisplay

mit Seitenschutz
.....▶

Foto: Bäckerei Vielhaber Stockum

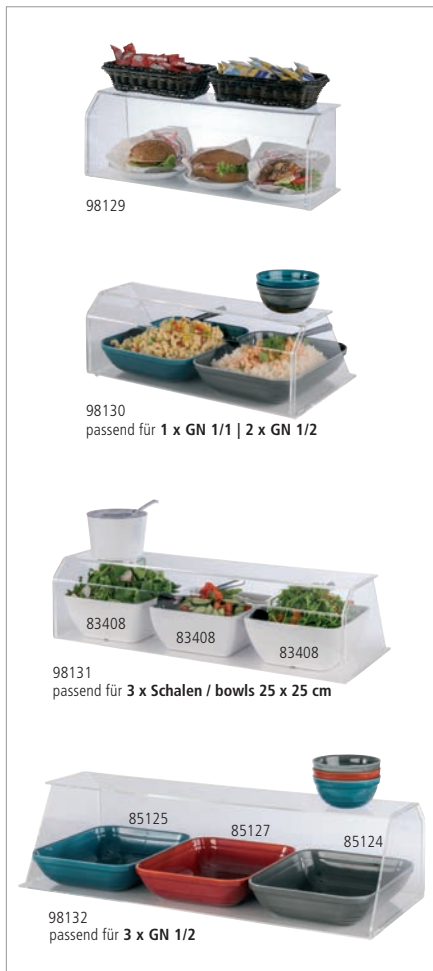

Thekendisplay

showcase
vitrina de mostrador
vitrine de comptoir

ACRYL
ACRYLIC

NON
SLIP FEET

Made in
Germany

mit Antirutsch-Füßchen, Seitenwände herausnehmbar
with non-slip feet, removable side panels
con pies antideslizantes, paneles laterales desmontables
avec pieds antidérapants, panneaux latéraux amovibles

	cm	↑ cm	fits to
98129	56,0 x 20	21,0	
98130	56,0 x 33	21,0	1 x GN 1/1, 2 x GN 1/2
98131	82,5 x 33	22,5	
98132	102,5 x 33	25,5	3 x GN 1/2



Servierbeispiele
presentation example



NEW BUFFET GUARD

3 Höhen einstellbar
3 heights adjustable

schwenkbar
swivelling

Servierbeispiel
presentation example

79 cm

83500 12232

Hygieneschutz „BUFFET GUARD“

sneeze guard
protector anti aliento
pare-haleine



- transparente, höhenverstellbare Acrylplatte 80 x 53 cm
- Neigungswinkel stufenlos einstellbar
- transparent, height-adjustable acrylic plate 80 x 53 cm
- tilt angle continuously adjustable
- placa acrílica transparente y de altura ajustable 80 x 53 cm
- el ángulo de inclinación es infinitamente variable
- plaque en acrylique transparente 80 x 53 cm et réglable en hauteur
- angle d'inclinaison variable à l'infini

	cm	↑ cm	✂ mm	Fuß / base
98120	93 x 53	50,5	5	Metall schwarz / metal black



Antirutsch-Füßchen
non-slip feet



Der Neigungswinkel der Acrylplatte ist flexibel einstellbar
the angle of inclination of the acrylic plate is flexibly adjustable

Höheneinstellung der Acrylplatte in
3 Höhen (20 cm - 30 cm - 40 cm)
height adjustment of the acrylic plate in
3 steps. (20 cm - 30 cm - 40 cm)

Schalen / bowls 25 x 25 cm
6 x 83918

Anwendungsbeispiel
application example

Lieferung erfolgt demontiert
delivery takes place disassembled

NEW Schubladen Set



3-teiliges Set
3 pcs. set



mit Antirutsch Füßchen
with non-slip feet



Schubladen Set, 3-tlg.
drawer set, 3 pcs.
cajonera, set de 3
set tiroir, set de 3



3-teiliges Set:

- 1 Ständer aus Metall schwarz
- 1 Schublade mit Griff schwarz
- 1 Schneidebrett aus geöltem Walnussholz

3 pcs. set:

- 1 stand made of metal black
- 1 drawer with handle black
- 1 oiled walnut wood cutting board

set de 3:

- 1 soporte de metal negra
- 1 cajón con asa negra
- 1 tabla de cortar de madera de nogal engrasada

set de 3:

- 1 support métallique noire
- 1 tiroir avec poignée noire
- 1 planche à découper en bois de noyer huilé

	cm	↑ cm
00910	35,4 x 32,5	20

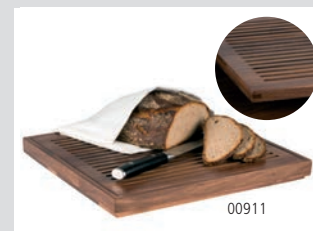

Anwendungsbeispiele
application examples

Einzelteile / parts / piezas / pièces

	cm	↑ cm	
00911	35,4 x 32,5	3,5	Schneidebrett / cutting board
00912	34,0 x 32,0	17,5	Schublade, Griff schwarz / drawer, handle black
00914	34,0 x 32,0	17,5	Schublade, Griff chrom / drawer, handle chrome
15503	35,4 x 32,5	17,6	GN Buffetständer chrom / GN buffet stand chrome
15506	35,4 x 32,5	17,6	GN Buffetständer schwarz/ GN buffet stand black

NEW



Neigungswinkel stufenlos einstellbar
inclination angle continuously adjustable

für 3 versch. Haubengrößen
for 3 different cover sizes

06519 Ø 21 cm
06520 Ø 30 cm
06521 Ø 36 cm



Haubhalterung „FLEXIBLE“

cover holder
soporte de la cubierta
support de la cloche



Bei dieser Haubhalterung wird die Haube am Griff in die Vorrichtung gesteckt.
Für APS-Hauben geeignet!

With this cover holder, the cover is inserted into the device by the handle.
Suitable for APS covers!

Con este soporte de campana, la campana se cuelga simplemente por el asa.
¡Para campanas de APS!

Avec ce support, la cloche s'accroche simplement par la poignée.
Pour cloches APS!

	cm	↑ cm
33288	35,5 x 30	39



Anwendungsbeispiele
application examples

NEW



24 cm

Haube | cover
Ø 16 cm



Tablett | tray
Ø 18,5 cm

Tablett mit Haube

tray with cover
bandeja con campana
plateau avec cloche



2 teiliges Set:

- 1 Tablett aus geöltem Buchenholz (Ø 18,5 cm, H: 2,5 cm)
- 1 Glas-Haube (Ø 16 cm, H: 22,5 cm)

2 pcs. set:

- 1 tray of oiled beech wood (Ø 18,5 cm, H: 2,5 cm)
- 1 glass cover (Ø 16 cm, H: 22,5 cm)

set de 2:

- 1 bandeja de madera de haya (Ø 18,5 cm, H: 2,5 cm)
- 1 campana de cristal (Ø 16 cm, H: 22,5 cm)

set de 2:

- 1 plateau de bois de hêtre (Ø 18,5 cm, H : 2,5 cm)
- 1 couvercle en verre (Ø 16 cm, H : 22,5 cm)

	Ø cm	↑ cm
00830	18,5	24

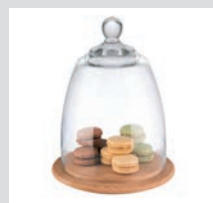

Präsentationsmöglichkeit
presentation example

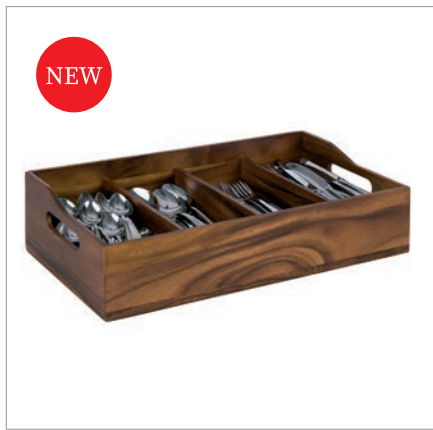

Besteckbehälter „ACACIA“

cutlery box
recipiente para cubiertos
récipient pour couverts

HOLZ
WOOD

Akazienholz natur, 4 Fächer (26 x 11,5 cm)
acacia wood nature, 4 compartments (26 x 11,5 cm)
madera de acacia natural, 4 compartimentos (26 x 11,5 cm)
bois d'acacia naturel, 4 compartiments (26 x 11,5 cm)

	cm	↑ cm	Farbe / Colour
11952	51 x 28	13	

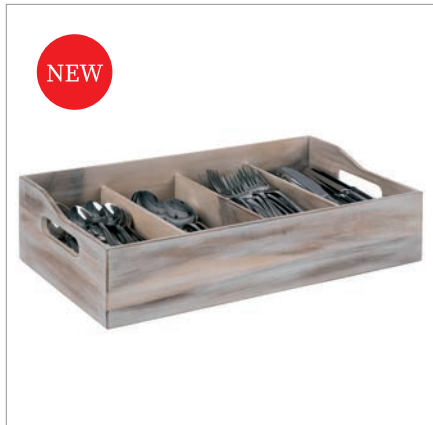

Besteckbehälter „VINTAGE“

cutlery box
recipiente para cubiertos
récipient pour couverts

HOLZ
WOOD

Akazienholz vintage weiß, 4 Fächer (26 x 11,5 cm)
acacia wood, vintage white, 4 compartments (26 x 11,5 cm)
madera de acacia, blanca vintage, 4 compartimentos (26 x 11,5 cm)
bois d'acacia, blanc vintage, 4 compartiments (26 x 11,5 cm)

	cm	↑ cm	Farbe / Colour
11951	51 x 28	13	



Besteckbehälter „ACACIA“ mit Deckel

cutlery box with cover
caja de cubiertos con tapa
range-couverts avec couvercle

HOLZ
WOOD

ACRYL
ACRYLIC



Akazienholz natur, 4 Fächer (26 x 11,5 cm)
acacia wood nature, 4 compartments (26 x 11,5 cm)
madera de acacia natural, 4 compartimentos (26 x 11,5 cm)
bois d'acacia naturel, 4 compartiments (26 x 11,5 cm)

	cm	↑ cm	Farbe / Colour
11949	51 x 28	14,5	



Besteckbehälter „VINTAGE“ mit Deckel

cutlery box with cover
caja de cubiertos con tapa
range-couverts avec couvercle

HOLZ
WOOD

ACRYL
ACRYLIC



Akazienholz vintage weiß, 4 Fächer (26 x 11,5 cm)
acacia wood, vintage white, 4 compartments (26 x 11,5 cm)
madera de acacia, blanca vintage, 4 compartimentos (26 x 11,5 cm)
bois d'acacia, blanc vintage, 4 compartiments (26 x 11,5 cm)

	cm	↑ cm	Farbe / Colour
11948	51 x 28	14,5	



GN „SUPERBOX“

Akazienholz
acacia wood
madera de acacia
bois d'acacia



	cm	↑ cm	GN	Farbe / Colour
11721 NEW	55,5 x 35,0	20	GN 1/1	
11723 NEW	55,5 x 35,0	20	GN 1/1	
11620	55,5 x 35,0	10,5	GN 1/1	
11626	55,5 x 35,0	10,5	GN 1/1	
11722 NEW	35,0 x 29,0	20	GN 1/2	
11724 NEW	35,0 x 29,0	20	GN 1/2	
11621	35,0 x 29,0	10,5	GN 1/2	
11627	35,0 x 29,0	10,5	GN 1/2	



Präsentationsmöglichkeiten
presentation examples



Brottschneidebrett

cutting board
tabla para cortar
planche à découper



Schneidebrett aus geöltem Walnussholz mit Antirutsch-Füßchen
with non-slip-feet oiled walnut wood cutting board
tabla de cortar de nogal engrasada con pies antideslizantes
planche à découper en bois de noyer huilé avec pieds antidérapants

	cm	↑ cm	GN
00911	35,4 x 32,5	3,5	GN 2/3

mit herausnehmbarem Krümfach
with removable crump shelf



Induktionsstation



inkl. Induktionskochplatte 900 Watt

Die Induktionsstation mit Regler präsentiert sich in einem Set aus Walnussholz, einem schwarzen Metallständer und einer Induktionsheizung.

The induction station with controller is presented in a set of walnut wood, a black metal stand and an induction heater.

La estación de inducción con regulador se presenta en un set formado por una caja de madera de nogal, un soporte de metal negro y un calentador de inducción.

La station à induction avec température réglable se compose d'un caisson en bois noyer, d'un support métallique noir et d'une plaque à induction.



Induktionsstation, 4-tlg. Set

induction station, 4 pcs.
estación de inducción, set de 4
station d'induction, set de 4



- 4 teiliges Set:
- 1 Induktionskochplatte mit Regler (Ø 24 cm, 900 Watt)
 - 1 Metallständer schwarz
 - 1 Rahmen aus Walnussholz geölt
 - 1 Edelstahlrahmen

- 4 pcs. set:
- 1 induction hotplate with controller (Ø 24 cm, 900 Watt)
 - 1 metal stand black
 - 1 frame in oiled walnut wood
 - 1 stainless steel frame

- set de 4:
- 1 placa de inducción con regulador (Ø 24 cm, 900 vatios)
 - 1 soporte de metal negro
 - 1 caja de madera de nogal aceitada
 - 1 marco de acero inoxidable

- set de 4:
- 1 plaque d'induction avec température réglable (Ø 24 cm, 900 watts)
 - 1 support métallique noir
 - 1 caisson en bois noyer huilé
 - 1 cadre en acier inox

	cm	↑ cm
12270	35,4 x 32,5	19



passendes Chafing Dish Set 12330
suitable chafing dish set 12330

Ersatzteile / replacement parts / piezas de repuesto / pièces de rechange

	cm	↑ cm	
12271	35,4 x 32,5	8,5	Holzrahmen / wooden frame
12272	29,5 x 26,5	1	Edelstahlrahmen / stainless steel frame
12295	Ø 24	-	900 Watt Induktionskochplatte / induction plate
15506	35,4 x 32,5	17,6	Buffetständer schwarz / buffet stand black

NEW



12330

4 tlg.
4 pcs.



12335

4 tlg.
4 pcs.



12336

4 tlg.
4 pcs.



12337

4 tlg.
4 pcs.



12329

4 ltr.

Chafing Dish, 4-tlg. Set

chafing dish set, 4 pcs.

chafing dish, set de 4

chafing dish, set de 4



4 teiliges Set:

- 1 Topf (8 Liter)
- 1 Speisenbehälter (4 Liter)
- 1 Deckel mit Sichtfenster und 1 Deckelbremse,
- Topf mit induktionsfähigem Sandwich- / Kapselboden

4 pcs. set:

- 1 pot (8 litres),
- 1 foodpan (4 litres)
- 1 lid with glass insert and 1 automatic lid brake
- pot with induction-compatible sandwich base

set de 4:

- 1 olla (8 litros)
- 1 cubeta (4 litros)
- 1 tapa con ventanilla y 1 sistema de freno en la tapa
- olla con base sandwich apta para inducción

set de 4:

- 1 casserole (8 litres)
- 1 bac (4 litres)
- 1 couvercle avec fenêtre et 1 système de frein dans le couvercle
- casserole avec fond sandwich pour induction

	Ø cm	↑ cm	ltr.	Farbe / Colour
12330	30,5	17,5	4	
12335	30,5	17,5	4	
12336	30,5	17,5	4	
12337	30,5	17,5	4	



12336

abnehmbarer Deckel
removable lid



induktionsgeeignet
suitable for induction

Ersatz-Speisenbehälter zu Chafing Dish / replacement foodpan for chafing dish / cubeta interior de repuesto para chafing dish / bac intérieur de remplacement pour le chafing dish

	Ø cm	↑ cm	ltr.	fits to
12329	30,5	8	4	12330, 12335, 12336, 12337



Ø 33 cm

8 ltr. Topf
8 ltr. pot



Sandwich- / Kapselboden
sandwich base



Ø 30,5 cm

4 ltr. Speisenbehälter
4 ltr. foodpan



Deckelbremse
automatic lid break



NEW WINDOW

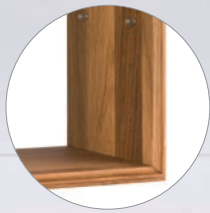

Eichenholz geölt
oak wood oiled



Buffetständer „WINDOW“
buffet stand
soporte para buffet
présentoir buffet

HOLZ
WOOD

Eichenholz geölt
oak wood oiled
madera de roble aceitada
bois de chêne huilé

	cm	↑ cm	
11740	35,5 x 19	37	inkl. 20 Haltestiften für Einlegeböden / incl. 20 fixing pins for shelves

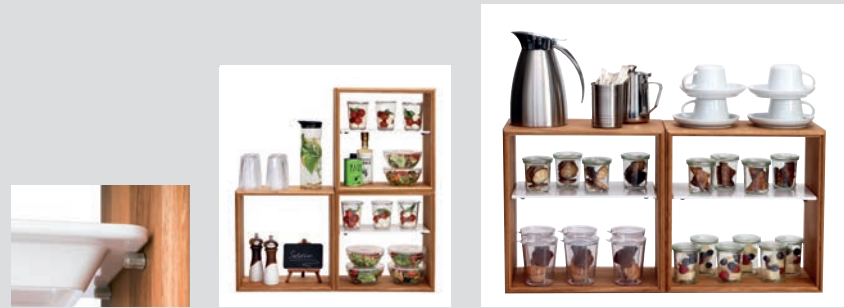

inkl. 20 Haltestifte
incl. 20 fixing pins

Präsentationsmöglichkeiten
presentation examples

geeignet für GN 1/3 Tablett / for GN 1/3 trays / para bandejas GN 1/3 / pour plateaux GN 1/3

	cm	↑ cm	Farbe / Colour
83832	32,5 x 17,6	2,5	
84187	32,5 x 17,6	1,5	
84197	32,5 x 17,6	1,5	
83481	32,5 x 17,6	3,0	
83491	32,5 x 17,6	3,0	





Serviergestell
29 x 19,5 cm | H 43 cm
no. 33220



Serviergestell „INDUSTRIAL“

servicing stand
soporte platos
présentoir à assiettes



für Teller max. Ø 27 cm, innerer Ring Ø 18 cm, Lieferung ohne Teller
for plates max. Ø 27 cm, circle inside Ø 18 cm, delivery without dishes
para platos máx. Ø 27 cm, aro interior Ø 18 cm, se entrega sin platos
pour assiettes Ø 27 cm maxi., anneau intérieur Ø 18 cm, livré sans assiettes

	cm	↑ cm		passend für Tellerabdeckhauben / suitable for plate cover
33208	29 x 19,5	30	2 Teller Ø 27 cm innerer Ring Ø 18 cm	11051, 11052
33209	29 x 19,5	43	3 Teller Ø 27 cm innerer Ring Ø 18 cm	11051, 11052



Tellerabdeckhaube

plate cover
cubierta para plato
couverture pour assiette



passend für unterschiedliche Tellergrößen

suitable for different plate sizes
aptas para diferentes tamaños de platos
aptes pour différentes tailles d'assiettes

	Ø cm	↑ cm	passend für unterschiedliche Tellergrößen / suitable for different plate sizes
11051	22,0	7,0	Ø 21,5 cm
11052	24,0	7,5	Ø 22,5 - 23,0 cm
11053	28,0	6,5	Ø 26,0 - 26,5 cm
11054	28,5	6,5	Ø 27,0 - 27,5 cm



Servierbeispiele
presentation examples



passende Hauben
suitable covers 11051, 11052

NEW SERVING-BOX „L“



7 tlg.
7 pcs.

**FOR
INDOOR &
OUTDOOR USE**
ROOM-, POOL-
& BEACH-
SERVICE,...



Serving-Box „L“

servicing box
caja comida
boîte-repas



7 teiliges Set:

- 1 Box + 1 Deckel
- 1 Schale groß (23 x 14 x 6 cm, 1,4 ltr.)
- 1 Schale mittel (14 x 11,5 x 6 cm, 0,6 ltr.)
- 2 Schalen klein (11,5 x 7 x 6 cm, 0,25 ltr.)
- 1 Antirutsch-Matte (26 x 21 cm)

Deckel und Box in Holzoptik, innen weiß

7 pcs. set:

- 1 box + 1 cover
- 1 bowl large (23 x 14 x 6 cm, 1,4 ltr.)
- 1 bowl medium (14 x 11,5 x 6 cm, 0,6 ltr.)
- 2 bowls small (11,5 x 7 x 6 cm, 0,25 ltr.)
- 1 non-slip mat (26 x 21 cm)

cover and box in wooden look, inside white

set de 7:

- 1 caja + 1 tapa
- 1 cuenco, grande (23 x 14 x 6 cm, 1,4 ltr.)
- 1 cuenco mediano (14 x 11,5 x 6 cm, 0,6 ltr.)
- 2 cuencos pequeños (11,5 x 7 x 6 cm, 0,25 ltr.)
- 1 esterilla antideslizante (26 x 21 cm)

tapa y caja con aspecto madera, interior blanco

set de 7:

- 1 boîte + 1 couvercle
- 1 bol, grand (23 x 14 x 6 cm, 1,4 ltr.)
- 1 bol moyen (14 x 11,5 x 6 cm, 0,6 ltr.)
- 2 bols petits (11,5 x 7 x 6 cm, 0,25 ltr.)
- 1 tapis antidérapant (26 x 21 cm)

couvercle et boîte extérieur aspect bois, intérieur blanc

	cm	↑ cm	Farbe / Colour
85091	30 x 25	8	



stapelbar
stackable



Anwendungsbeispiel
application example

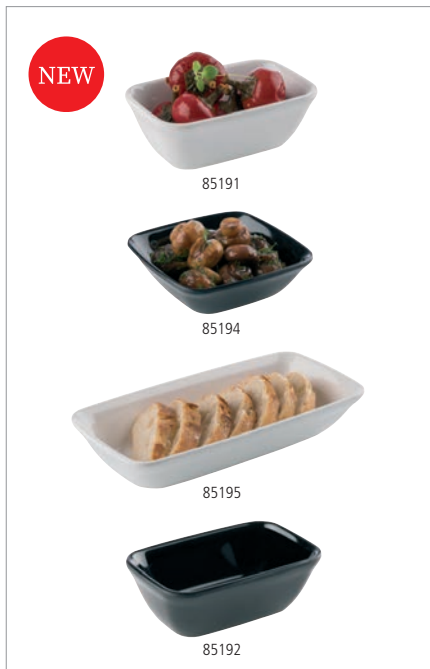

Schalen
bowls
cuencos
bols



	cm	↑ cm	ltr.	Farbe / Colour
85191	10,0 x 6,5	3,5	0,10	■
85193	10,0 x 10,0	3,5	0,15	■
85195	20,0 x 10,0	3,5	0,40	■
85192	10,0 x 6,5	3,5	0,10	■
85194	10,0 x 10,0	3,5	0,15	■
85196	20,0 x 10,0	3,5	0,40	■



Teller
plates
platos
assiettes



	cm	↑ cm	ltr.	Farbe / Colour
85197	21,5 x 21,5	2	-	■
85198	21,5 x 21,5	2	-	■



Schale „POKE BOWL“
bowl
cuenco
bol



	Ø cm	↑ cm	ltr.	Farbe / Colour
85003	20	7	0,9	■ white
85005	20	7	0,9	■ coconut
85000	16	9	1,1	■ white
85002	16	9	1,1	■ coconut
85006	20	9	1,6	■ white
85008	20	9	1,6	■ coconut

NEW

MOON



Servierset „MOON“, 6-tlg.
 serving set, 6 pcs.
 set para servir, set de 6
 set de service, set de 6



6-teiliges Set: 3 Schalen + 3 Löffel
 6 pcs. set: 3 bowls + 3 spoons
 set de 6: 3 cuencos + 3 cucharas
 set de 6: 3 bols + 3 cuillères

	Ø cm	↑ cm	ltr.	Farbe / Colour
85080	8	7,5	0,05	
85081	8	7,5	0,05	





Servierset „MOON“, 2-tlg.
 serving set, 2 pcs.
 set para servir, set de 2
 set de service, set de 2



2-teiliges Set: 1 Schale + 1 klappbarer Deckel
 2 pcs. set: 1 bowl + 1 hinged cover
 set de 2: 1 cuenco + 1 tapa con bisagra
 set de 2: 1 bol + 1 couvercle avec charnières

	Ø cm	↑ cm	ltr.	Farbe / Colour
85082	19	17,5	0,8	■
85083	19	17,5	0,8	■

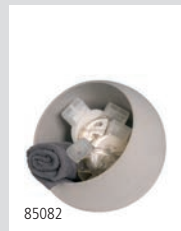

Klappbarer Deckel
 hinged cover

Präsentationsmöglichkeit
 presentation example

Klappdeckel „Moon“ mit Silikondichtung / hinged cover with silicone seal / tapa con bisagra con junta de silicona / couvercle avec charnières avec joint en silicone

	Ø cm	↑ cm	fits to
85084	16	1,5	85082, 85083

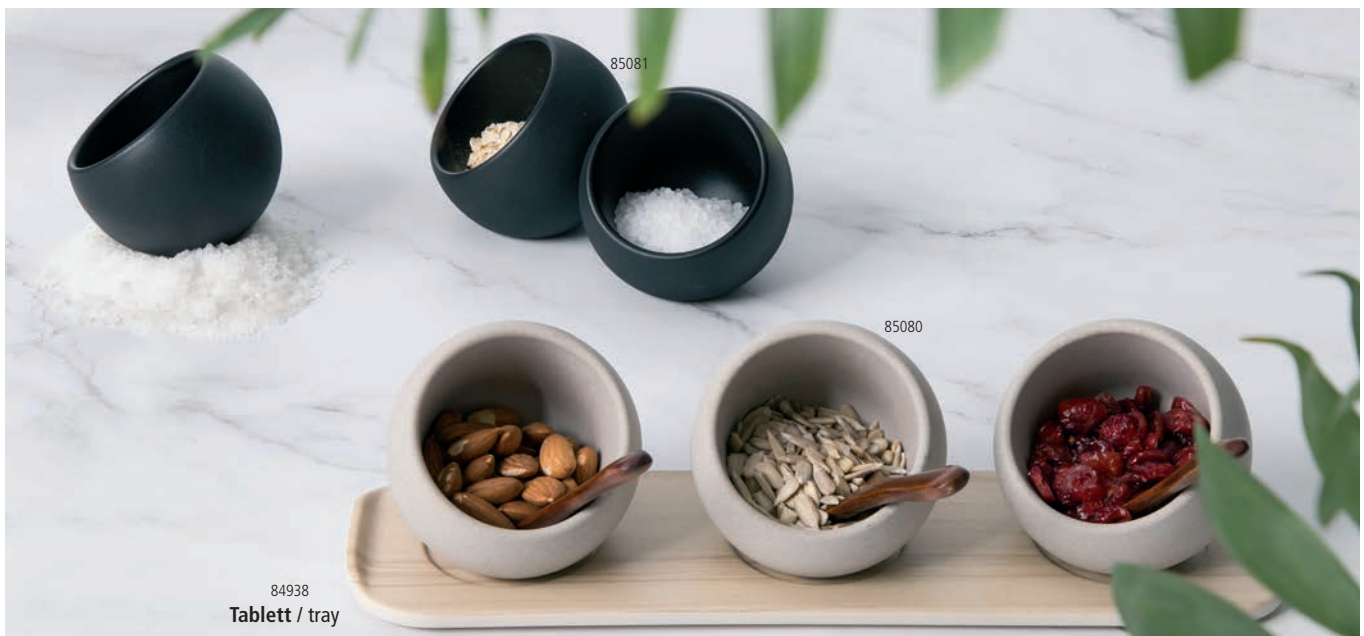

NEW EMMA

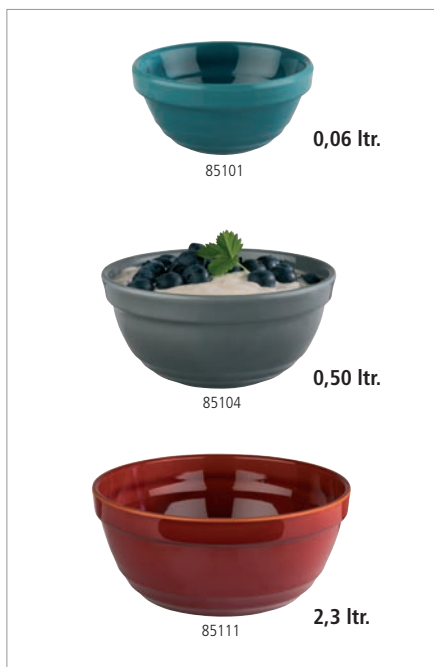

Schale „EMMA“
bowl
cuenco
bol



	Ø cm	↑ cm	ltr.	Farbe / Colour
85100	7,5	3,5	0,06	■
85101	7,5	3,5	0,06	■
85103	7,5	3,5	0,06	■
85104	14	6,5	0,5	■
85105	14	6,5	0,5	■
85107	14	6,5	0,5	■
85108	23	10,5	2,3	■
85109	23	10,5	2,3	■
85111	23	10,5	2,3	■



Teller „EMMA“
plate
plato
assiette



	Ø cm	↑ cm	Farbe / Colour
85112	32	3,5	■
85113	32	3,5	■
85115	32	3,5	■
85116	40,5	5,5	■
85117	40,5	5,5	■
85119	40,5	5,5	■





GN Tablett „EMMA“

GN tray
GN bandeja
GN plateau



	cm	↑ cm	GN	Farbe / Colour
85120	26,5 x 16,2	3	1/4	■
85121	26,5 x 16,2	3	1/4	■
85123	26,5 x 16,2	3	1/4	■
85124	32,5 x 26,5	3	1/2	■
85125	32,5 x 26,5	3	1/2	■
85127	32,5 x 26,5	3	1/2	■

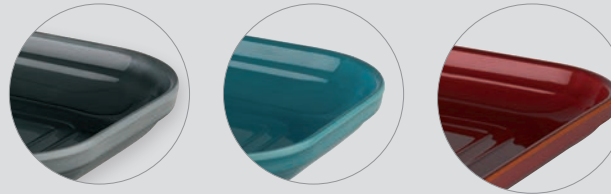

GN Schale „EMMA“

GN bowl
GN cuenco
GN bol



	cm	↑ cm	ltr.	GN	Farbe / Colour
85128	26,5 x 16,2	7,5	1,5	1/4	■
85129	26,5 x 16,2	7,5	1,5	1/4	■
85131	26,5 x 16,2	7,5	1,5	1/4	■
85132	32,5 x 26,5	7,5	3,5	1/2	■
85133	32,5 x 26,5	7,5	3,5	1/2	■
85135	32,5 x 26,5	7,5	3,5	1/2	■

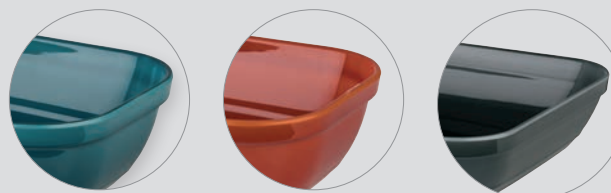

❄️ Cooling bowl ❄️



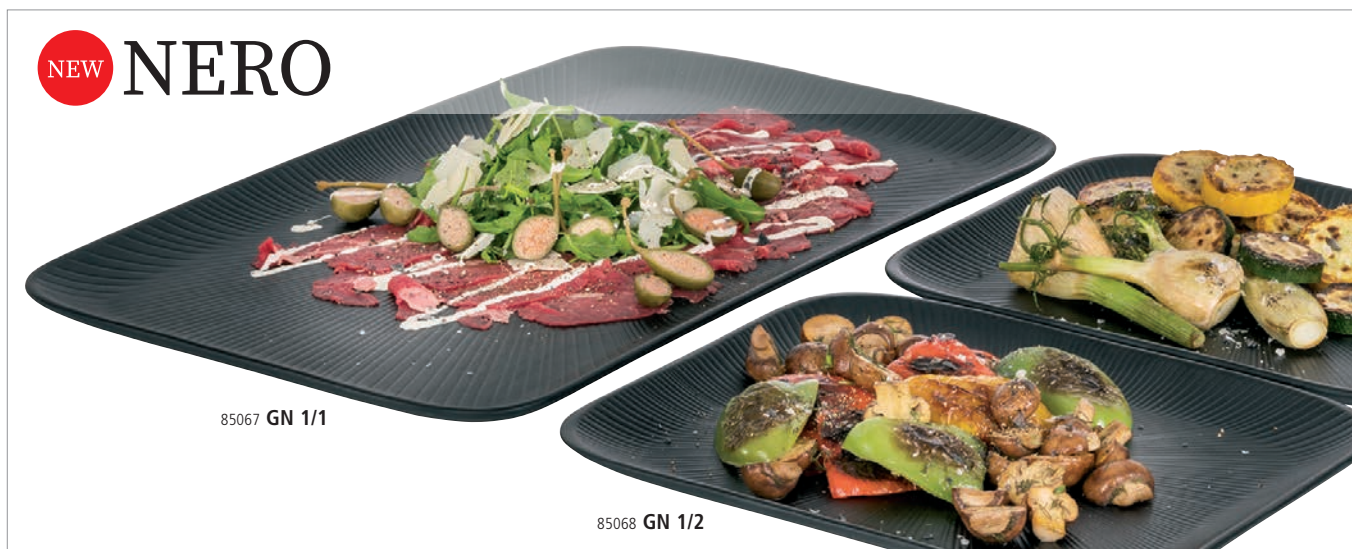

NEW **NERO**

85067 GN 1/1

85068 GN 1/2



85067 GN 1/1

85068 GN 1/2

GN Tablett „NERO“

GN tray
GN bandeja
GN plateau



	cm	↑ cm	GN
85067	53,0 x 32,5	2,5	1/1
85068	32,5 x 26,5	2,5	1/2

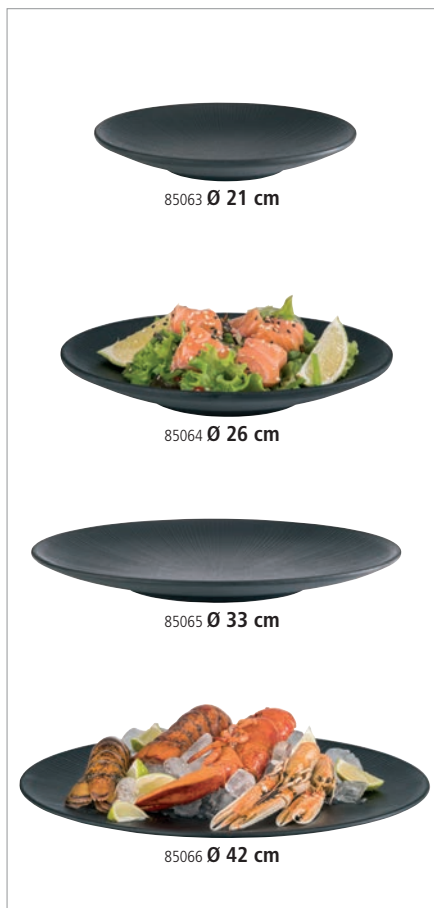
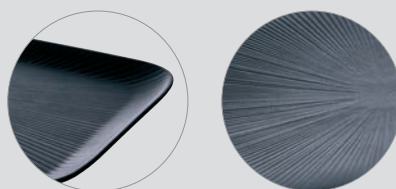

85063 Ø 21 cm

85064 Ø 26 cm

85065 Ø 33 cm

85066 Ø 42 cm

Teller „NERO“

plate
plato
assiette



	Ø cm	↑ cm
85063	21	3
85064	26	3
85065	33	3,5
85066	42	3,5

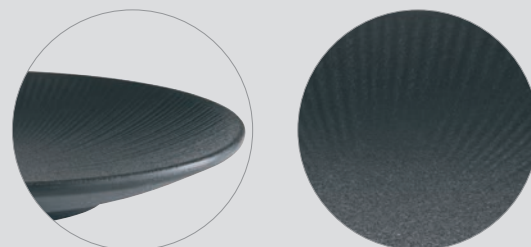



Schale „NERO“

bowl
cuenco
bol



	Ø cm	↑ cm	ltr.
85069	16	6,5	0,5
85070	19	8,0	0,9
85061	24	9,0	1,7

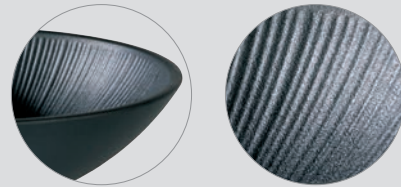

Schale „NERO“

bowl
cuenco
bol



	Ø cm	↑ cm	ltr.
85060	22,5	4,5	0,8
85062	30,0	7,0	2,2

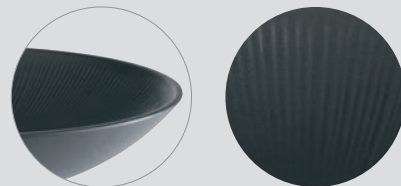

Schale „NERO“

bowl, square
cuenco, cuadrado
bol creux carré



	cm	↑ cm	ltr.
85071	19,5 x 19,5	8	1,5
85072	25,0 x 25,0	11	3,5

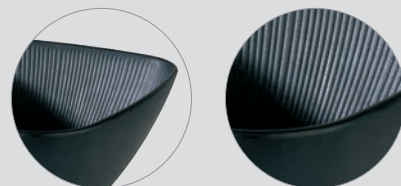

NEW SUPER CUP

IDEAL
FÜR
„TAKE AWAY“



Der transparente Becher aus **recyclbarem** Kunststoff ist vielseitig einsetzbar:

- Buffet
- Catering
- Kantine
- Bäckerei & Coffee Shop
- Pool & Beach



Mehrweg
statt Einweg
TO GO ! ...

Eigenschaften:

- aus schlagfestem, transp. Kunststoff
- leichter als Glas
- nahezu unzerbrechlich
- für kalte und warme Speisen
- Gebrauchstemperatur bis +80°C
- langlebig und ökologisch sinnvoll

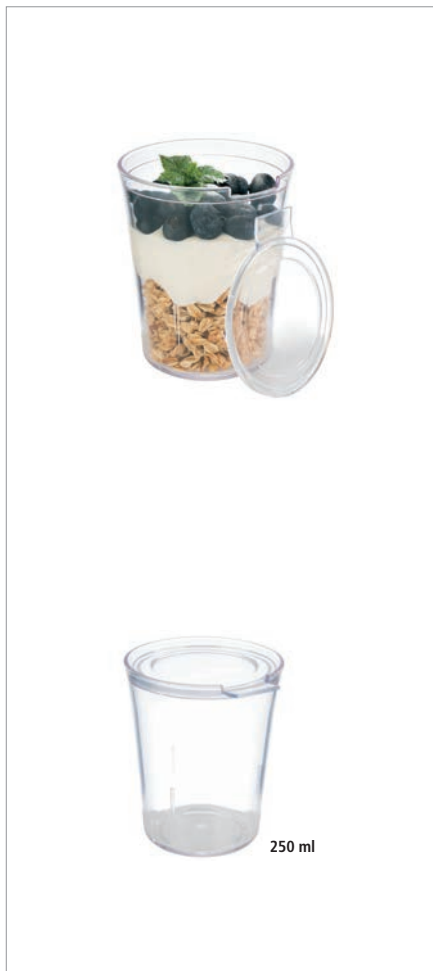

Becher Set „SUPER CUP“, 16-tlg.

barrel mug set, 16 pcs.
vasos, set de 16
gobelets, set de 16



16-teiliges Set: 8 Becher + 8 Deckel

16 pcs. set: 8 barrel mugs + 8 lids

set de 16: 8 vasos + 8 tapas

set de 16: 8 gobelets + 8 couvercles

	Ø cm	↑ cm	ltr.
10506	8	10	0,25



mit Stapelnocke
with stacking cam



rutschfester Deckel
non-slip lid



Servierbeispiel Deckel
presentation example cover



250 ml



Schale „PADELLA“
bowl
cazuelita
plat 2 anses „cocotte“



	Ø cm	↑ cm	ltr.	Griff / handle cm
85150	21	9	1,5	5 x 3,5
85151	28	9	3,0	5 x 3,5



stapelbar und rutschfest
stackable and nonslip

Detailansicht
close up view



Set „CASUAL“, 4-tlg.
set, 4 pcs.
set de 4
set de 4



4-teiliges Set:
• 2 Schalen + 2 Deckel
• dichtschießend

4 pcs. set:
• 2 bowls + 2 covers
• tightly closing

set de 4:
• 2 cuencos + 2 tapas
• con cierre hermético

set de 4:
• 2 bols + 2 couvercles
• fermeture hermétique

	Ø cm	↑ cm	ltr.	Farbe / Colour
85160	14	6,5	0,5	White
85161	14	6,5	0,5	Black
85162	20	9	1,8	White
85163	20	9	1,8	Black





Deckel „FRIDA“
cover
tapa
couvercle



	Ø cm	↑ cm	fits to
84962	9	2,5	84930, 84931
84963	13	2,5	84605, 84606
84964	16	2,5	84607, 84608

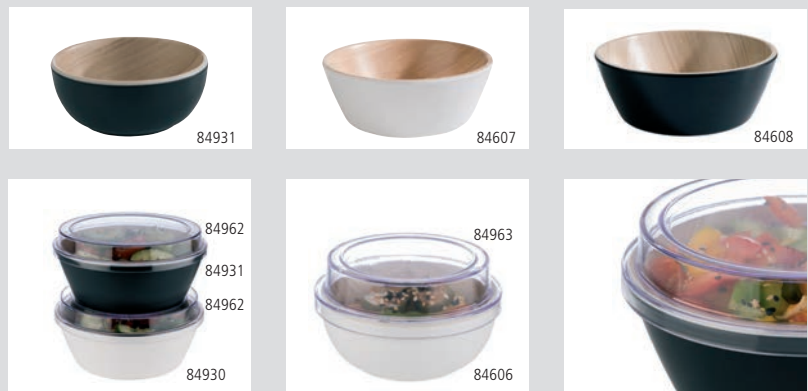

stapelbar / stackable



Deckel „FRIDA“
cover
tapa
couvercle



	cm	↑ cm	fits to
84965	13 x 13,0	2,5	84937, 84936
84966	17 x 17,0	2,5	84558, 84559
84967	18 x 16,5	2,5	84584, 84583
84968	18 x 11,0	2,5	84556, 84555

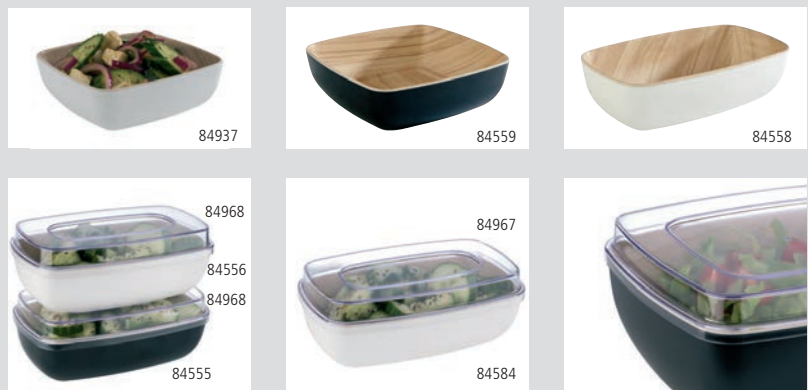

stapelbar / stackable

NEW



83603

passend zu Schalen 12,5 x 12,5 cm
fits to bowls 12,5 x 12,5 cm



83604

passend zu Schalen 19 x 19 cm
fits to bowls 19 x 19 cm

Deckel „PURE“, 5er Set

cover, 5 pcs. set
tapa, set de 5
couvercle, set de 5



Hygienischer Schutz für Ihre Speisen

- dichtschießend
- schwappsicherer Transport
- BPA-frei

protection for your food

- tightly closing
- slosh-proof transport
- bpa-free

protección de alimentos

- con cierre hermético
- transporte sin salpicaduras
- libre de BPA

protection des aliments

- fermeture hermétique
- transport sans éclaboussures
- sans BPA

	cm	↑ cm	VE	fits to
83603	13,0 x 13,0	0,5	5	83410, 83467, 83570, 83571, 84410, 84416, 84421
83604	19,5 x 19,5	0,5	5	83409, 83468, 83572, 83573, 84244, 84409, 84417, 84422, 84830



stapelbar und rutschfest
stackable and nonslip

NEW



83605

passend zu Schalen Ø 7,5 cm
fits to bowls Ø 7,5 cm



83606

passend zu Schalen Ø 14 cm
fits to bowls Ø 14 cm



83607

passend zu Schalen Ø 20 cm
fits to bowls Ø 20 cm

Deckel „CASUAL“, 5er Set

cover, 5 pcs. set
tapa, set de 5
couvercle, set de 5



Hygienischer Schutz für Ihre Speisen

- dichtschießend
- schwappsicherer Transport
- BPA-frei

protection for your food

- tightly closing
- slosh-proof transport
- bpa-free

protección de alimentos

- con cierre hermético
- transporte sin salpicaduras
- libre de BPA

protection des aliments

- fermeture hermétique
- transport sans éclaboussures
- sans BPA

	Ø cm	↑ cm	VE	fits to
83605	8,0	0,5	5	11866, 83881, 15400, 15408, 15416, 15461, 15462, 15467, 15468, 40655, 40656
83606	14,5	0,5	5	11865, 83700, 83701, 84990, 85104, 85105, 85107
83607	20,5	0,5	5	83704, 83705, 15105, 15230, 15404, 15412, 15420, 85003, 85005, 85006, 85008

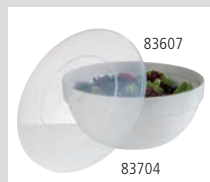

stapelbar / stackable

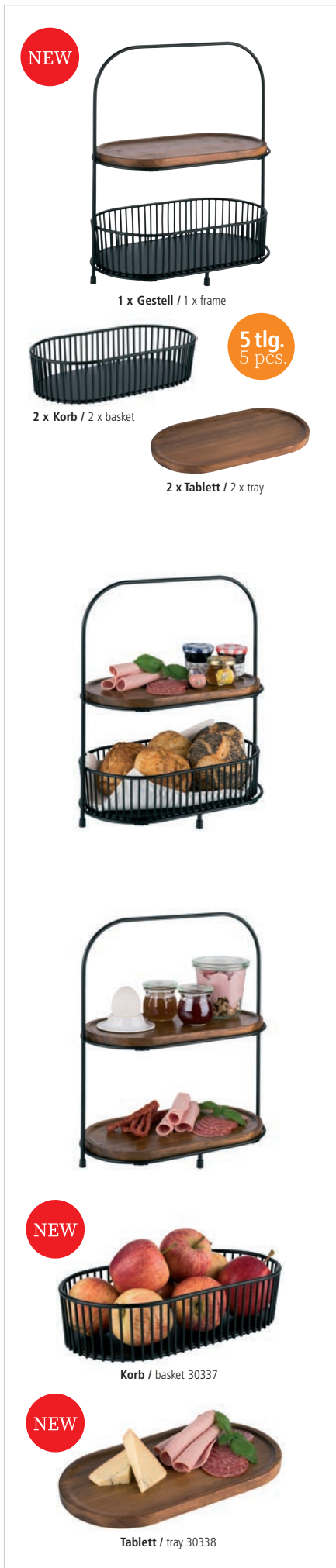

2-stufige Etagère „ALL-ROUNDER“, 5er Set

2 tier tray, 5 pcs. set
soporte 2 alturas, set de 5
étagère 2 niveaux, set de 5



5 teiliges Set:

- 1 Gestell aus Metall schwarz, mit Antirutschfüßchen,
- 2 Körbe aus Metall schwarz je 29 x 16 cm, H: 7 cm,
- 2 Servierbretter aus geöltem Akazienholz je 28,5 x 15,5 cm, H: 1,5 cm

5 pcs. set:

- 1 frame made of black metal with non-slip feet,
- 2 baskets of black metal each 29 x 16 cm, H: 7 cm,
- 2 boards of oiled acacia wood each 28,5 x 15,5 cm, H: 1,5 cm

set de 5:

- 1 soporte metálico, negro con pies antideslizantes,
- 2 cestas metálicas negras, cada una de 29 x 16 cm, H: 7 cm,
- 2 tablas de madera de acacia aceitada 28,5 x 15,5 cm, H: 1,5 cm

set de 5:

- 1 support métallique noir avec pieds antidérapants,
- 2 paniers métalliques noirs, chacune 29 x 16 cm, H: 7 cm,
- 2 planches d'acacia huilé, chacune 28,5 x 15,5 cm, H: 1,5 cm

	cm	↑ cm
30336	31 x 17	37,5

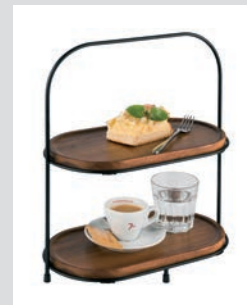
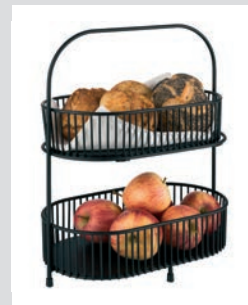

multifunktional,
ideal als

- Frühstücks-Etagère
- Vorspeisen-Etagère
- Kuchen-Etagère
- Brot-Etagère
- Gebäck-Etagère
- Früchte-Etagère

Präsentationsmöglichkeiten
presentation examples

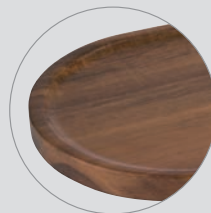

geöltes Akazienholz
oiled acacia wood



mit Antirutsch-Füßchen
with non-slip feet

Korb / basket / cesta / corbeille

	cm	↑ cm	Farbe / Colour
30337	29,0 x 16,0	7	■

Servierbrett / serving board / tabla de servir / planche de service

	cm	↑ cm	Farbe / Colour
30338	28,5 x 15,5	3,5	■

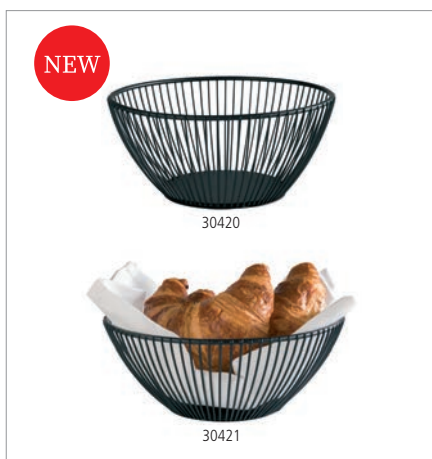

Korb „SVART“
basket
cesta
corbeille



	Ø cm	↑ cm
30420	17,5	8
30421	20,0	8

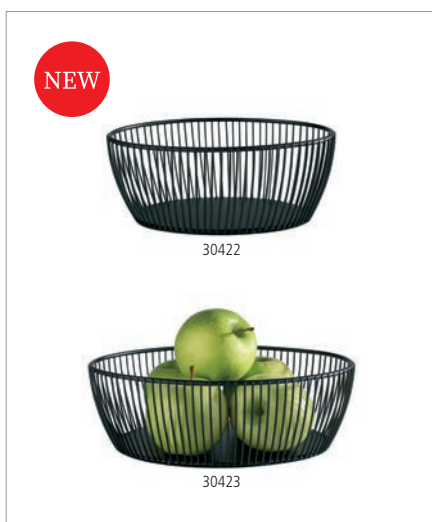

Korb „SVART“
basket
cesta
corbeille



	cm	↑ cm
30422	20 x 15	8
30423	24 x 19	8

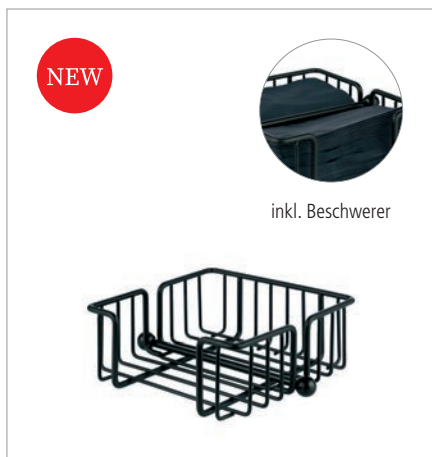

Serviettenhalter „URBAN“
napkin holder
servilletero
porte-serviettes



für ca. 50 Servietten, inkl. Beschwerer
for approx. 50 napkins, incl. weight
para aprox. 50 servilletas, incl. barra de contrapeso
pour environ 50 serviettes, incl. barre de contrepoids

	cm	↑ cm	
11770	19 x 19	7,5	für 50 Servietten / for 50 napkins para 50 servilletas / pour 50 serviettes



Serviettenhalter „URBAN“
napkin holder
servilletero
porte-serviettes



für ca. 120 Servietten 1/4 Falz, inkl. Beschwerer
for approx. 120 cocktail napkins, incl. weight
para aprox. 120 servilletas de plegado ¼, incl. barra de contrapeso
pour environ 120 serviettes pliage ¼, incl. barrie de contrepoids

	cm	↑ cm	
11771	19 x 19	18	für 120 Servietten / for 120 napkins para 120 servilletas / pour 120 serviettes



Die Teekanne „ASIA“ aus emailliertem Gußeisen mit abnehmbarem Deckel, inkl. Teesieb ist ein Muss für alle Teeliebhaber.

The „ASIA“ teapot made of enamelled cast iron with a removable lid, incl. tea strainer is a must for all tea lovers.

La tetera „ASIA“ de hierro fundido esmaltado con tapa extraíble que incluye un colador de té, es imprescindible para todos los amantes del té.

La théière „ASIA“ en fonte émaillée avec le couvercle amovible, y compris la passoire à thé, est un must pour tous les amateurs de thé.



Teekanne „ASIA“
teapot
tetera
théière



aus Gusseisen, innen emailliert, mit abnehmbarem Deckel, inkl. Teesieb aus Edelstahl, ideal für 2-3 Tassen. Geeignet für alle Herdarten.

made of cast iron, enamelled inside, with removable lid, incl. tea strainer made of stainless steel, ideal for 2-3 cups. Suitable for all types of stoves.

hierro fundido, interior esmaltado, con tapa extraíble, incl. colador de té de acero inoxidable, ideal para 2-3 tazas. Apta para todas las placas de cocina.

en fonte, émaillé à l'intérieur, avec couvercle amovible, y compris une passoire à thé en acier inox, idéale pour 2-3 tasses. Convient à tous les types de feux (gaz, vitro ou induction).

	cm	↑ cm	ltr.	Farbe / Colour
10991	19,5 x 18	15	0,8	■
10992	19,5 x 18	15	0,8	■

	cm	↑ cm	ltr.	Farbe / Colour
10990	12,5 x 11	12,5	0,3	■



Stövchen „ASIA“
teapot warmer
calentador de tetera
chauffe-théière



	∅ cm	↑ cm
10994	13	7,5

1-flammiges Stövchen aus Gusseisen mit abnehmbarem Deckel (Lieferung ohne Teelicht).

1-flame cast iron warmer with removable lid (delivery without tealight).

calentador de tetera de hierro fundido con 1 quemador con tapa amovible (se entrega sin vela).

chauffe-théière en fonte à 1 brûleur avec couvercle amovible (livraison sans bougie).



Lieferung ohne Teelicht
delivery without tealight



Untersetzer „ASIA“

coaster
reposa tetera
repose théière



Untersetzer aus Gusseisen mit Antirutsch-Füßchen
cast iron coaster with non-slip feet
reposa tetera de hierro fundido con pies antideslizantes
repose théière en fonte avec pieds antidérapants

	Ø cm	↑ cm
10993	13,5	1,5



Tablett

tray
bandeja
plateau



aus Bambus, geeignet zum Servieren und Transportieren
made of bamboo, suitable for serving and transport
de bambú, para servir y transportar
en bambou, pour servir et transporter

	cm	↑ cm	GN
00845	32,5 x 26,5	3	1/2
00846	32,5 x 17,6	3	1/3
00847	53,0 x 16,2	3	2/4

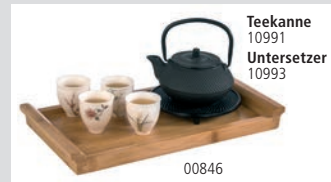

Präsentationsmöglichkeit
presentation example



2-stufige Etagère

2-tier étagère
cesta doble 2 alturas
étagère 2 paniers



Griff aus Holz, Körbe aus Metall schwarz,
oberer Korb (Ø 22 cm, H: 6 cm), unterer Korb (Ø 26 cm, H: 8 cm)
wooden handle, baskets made of metal black,
upper basket (Ø 22 cm, H: 6 cm), lower basket (Ø 26 cm, H: 8 cm)
mango de madera, soporte metálico negro,
cesta superior (Ø 22 cm, H: 6 cm), cesta inferior (Ø 26 cm, H: 8 cm)
manche en bois, paniers en métal noir,
panier supérieur (Ø 22 cm, H: 6 cm), panier inférieur (Ø 26 cm, H: 8 cm)

	Ø cm	↑ cm
30335	26	48



Präsentationsmöglichkeit
presentation example

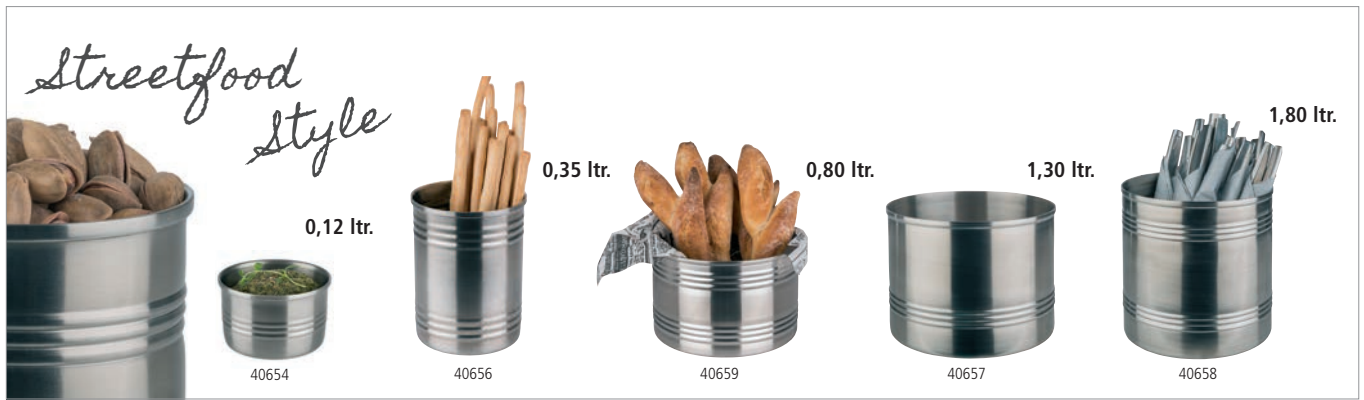

Snackcan

serving can
lata para aperitivos
boîte de conserves pour apéritifs



	Ø cm	↑ cm	ltr.	
40654 NEW	6,5	4,0	0,12	ideale Beilagen Größe
40655	7,5	5,5	0,17	
40656	7,5	10,0	0,35	
40659 NEW	12,0	8,0	0,80	
40658	13,5	14,0	1,80	
40657	13,5	10,5	1,30	

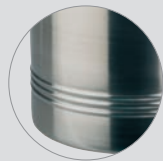

Edelstahl mattiert
stainless steel matt

NEW



30140



30141



30142

Serviertablett „KAFFEEHAUS VINTAGE“

tray
bandeja
plateau



Antik-Edelstahl-Look
stainless steel vintage look
acero inoxidable aspecto vintage
acier inox look vintage

	cm	↑ cm	
30140	20,0 x 14,5	1,0	für Zucker und Sahne / for sugar and cream
30141	26,5 x 19,5	1,0	für eine Tasse / for 1 cup
30142	29,0 x 22,0	1,0	für zwei Tassen / for 2 cups



Antique-Edelstahl-Look
stainless steel vintage look



Servierbeispiel
presentation example

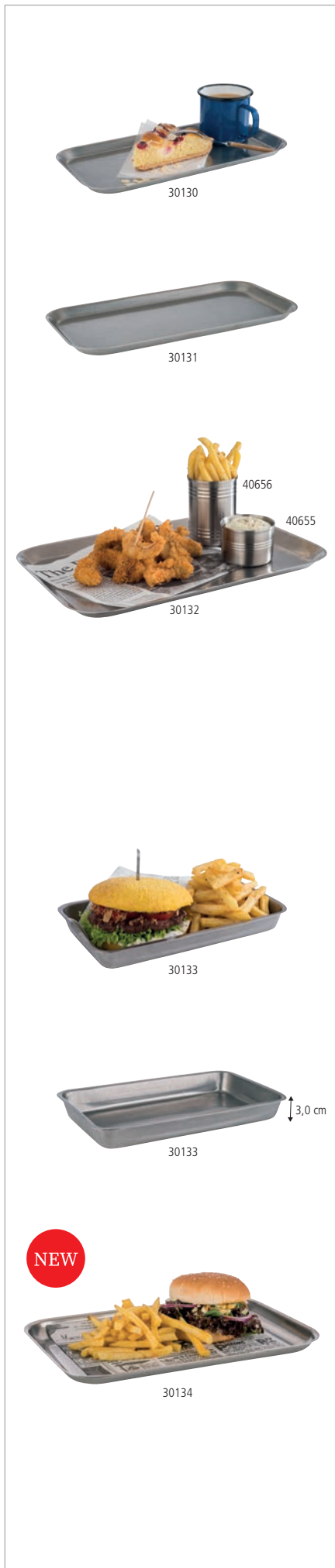

Tablett „VINTAGE“

tray
bandeja
plateau



Antik-Edelstahl-Look

stainless steel vintage look
acero inoxidable aspecto vintage
acier inox look vintage

	cm	↑ cm
30130	26,0 x 13,5	1,5
30131	34,0 x 18,0	1,5
30132	38,0 x 26,5	1,5
30133	25,5 x 16,0	3,0
30134 NEW	32,5 x 21,5	2,0

passende Schälchen / fitting bowls / cuencos compatibles / bols compatibles



	Ø cm	↑ cm	ltr.
40655	7,5	5,5	0,17
40656	7,5	10,0	0,35



Servierbeispiele
presentation examples

passendes Wachspapier / greaseproof paper squares / papel alimenticio / papier alimentaire

	cm	pcs.	
40677 NEW	25 x 20	1000	Motiv: Zeitung / newspaper
40678 NEW	31 x 31	1000	Motiv: Zeitung / newspaper
40679 NEW	34 x 28	1000	Motiv: Zeitung / newspaper
	cm	pcs.	
40672	42 x 25	500	Motiv: rote Karos / red
40673	42 x 25	500	Motiv: blaue Karos / blue
40674	30 x 20	500	Motiv: Fast Food / black
	cm	pcs.	
40670	42 x 25	500	Motiv: Zeitung / newspaper
40671	42 x 25	500	blank

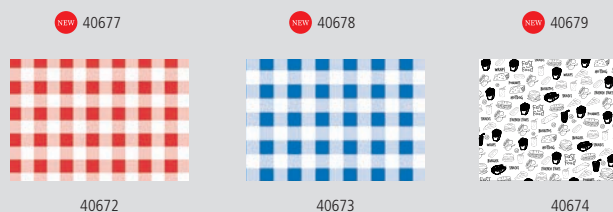



Vorspeisenzange „BANQUET“

appetizer tong
pinza para aperitivos
pince à apéritif



Vorderteil poliert, Stiel mattiert
front part: high-shiny, handle: matt-finish
parte delantera pulida, asa mate
partie avant polie, poignée matte

	cm	→ cm
75822	4,5 x 3,5	20



Ideal für Vorspeisen
ideal for starters



Universalzange

all-purpose tong
pinza universal
pince universelle



Edelstahl, Antik-Edelstahl-Look / Vintage-Look
stainless steel, stainless antique look
acero inoxidable, acero estilo antiguo
acier inox, acier style antique

	cm	→ cm
75823	5,5 x 5,0	20



Ideal für Geschnittenes
ideal for sliced products



Universalzange

all-purpose tong
pinza universal
pince universelle



Edelstahl, Antik-Edelstahl-Look / Vintage-Look
stainless steel, stainless antique look
acero inoxidable, acero estilo antiguo
acier inox, acier style antique

	cm	→ cm
75824	7 x 5	22,5



Universalzange

all-purpose tong
pinza universal
pince universelle



Edelstahl, Antik-Edelstahl-Look / Vintage-Look
stainless steel, stainless antique look
acero inoxidable, acero estilo antiguo
acier inox, acier style antique

	cm	→ cm
75825	7 x 5	22,5



Besteckbehälter

cutlery bin
recipiente para cubiertos
récipient pour couverts



Behälter aus Beton mit möbelschonender Unterseite und Abflussloch.
Inklusive Bodeneinlage aus Silikon zum Schonen des Bestecks.

cutlery bin with non-scratching undersurface and drain hole.
Including bottom is made of silicone to protect the cutlery.

Recipiente de hormigón con base anti rayaduras y orificio de drenaje.
Incluye un disco de silicona para proteger los cubiertos.

Récipient en béton avec revêtement antirayures et trou de drainage.
Comprend disque en Silicone pour protéger les couverts.

	Ø cm	↑ cm
11933	11,5	14,5



Flaschenkühler

bottle cooler
enfriador de botellas
rafraîchisseur de bouteilles



Flaschenkühler aus Beton mit möbelschonender Unterseite

bottle cooler with non-scratching undersurface

enfriador de hormigón con base anti rayaduras

rafraîchisseur en béton avec revêtement antirayures

	Ø cm	↑ cm
36094	13	18,5



GN 1/1 Besteckbehälter

GN 1/1 cutlery bin
GN 1/1 recipiente para cubiertos
GN 1/1 récipients pour couverts



	cm	↑ cm	Farbe / Colour
11954 <small>NEW</small>	53 x 32,5	10	■
11955	53 x 32,5	10	■



Stößel

muddler
mortero
pilon muddler



mit griffigem Ende, zum Auspressen von Früchten und Zerstoßen von Würfelzucker

with handy end, to press fruits or pound lump sugar

con un acabado en relieve para exprimir frutas y machacar azucarillos

avec relief grillagé pour presser les fruits ou le sucre en morceaux

	Ø cm	→ cm	Farbe / Colour
93362 <small>NEW</small>	3,5	20,5	antique-copper-look ■
93358	3,5	20,5	stainless steel ■
93360	3,5	20,5	copper-look ■
93361	3,5	20,5	stainless-antique look ■

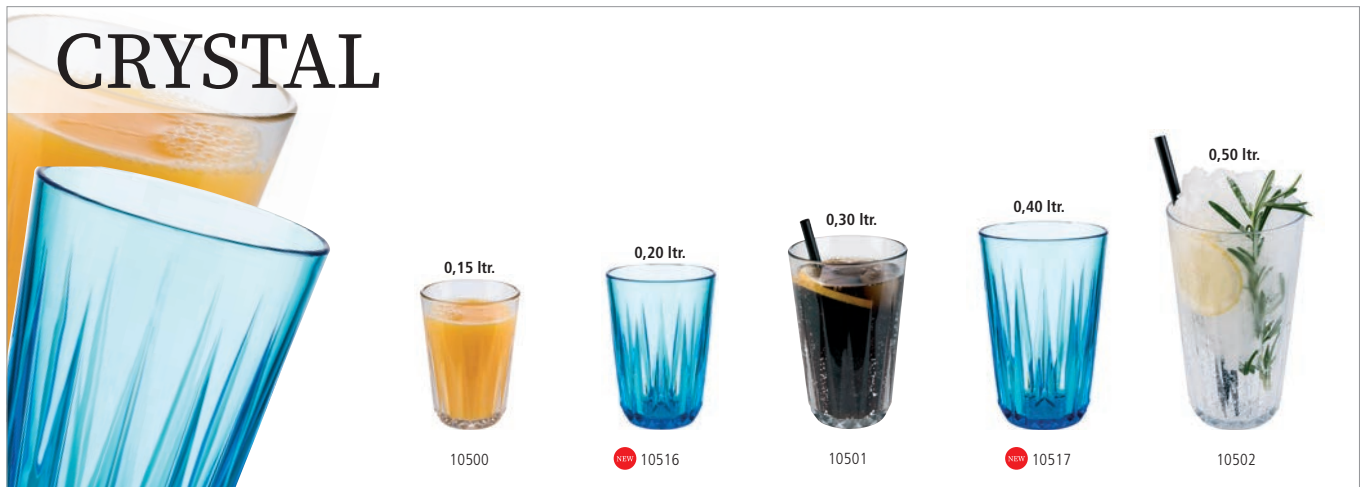

Trinkbecher „CRYSTAL“
drinking cups
vasos
gobelets



Kristallglas-Optik, vielseitig einsetzbar, robustes, unzerbrechliches Material, ideal in sensiblen Bereichen wie Pool, Spa, Beach und Wellness einzusetzen, BPA-frei
 crystal-glass-look, can be used in versatile ways, a solide and unbreakable material, ideal to be used at pool, spa, beach and wellness areas, bpa-free
 aspecto vidrio, se pueden utilizar de muchas maneras diferentes, material sólido e irrompible, ideal para el uso en áreas como piscina, spa, playa y bienestar, libre de BPA
 ressemble á un verre de cristal, peuvent être utilisés de différentes façons, matériau robuste et incassable, idéal pour une utilisation dans des zones comme la piscine, le spa, la plage et le bien-être, sans BPA

	Ø cm	↑ cm	ltr.	VE	Farbe / Colour
10500	7	9,5	0,15	48	—
10503 NEW	7,5	11,0	0,20	48	—
10501	8	12,5	0,30	48	—
10504 NEW	8,5	14,0	0,40	48	—
10502	9	15,5	0,50	48	—

	Ø cm	↑ cm	ltr.	VE	Farbe / Colour
10513	7	9,5	0,15	48	
10516 NEW	7,5	11,0	0,20	48	
10514	8	12,5	0,30	48	
10517 NEW	8,5	14,0	0,40	48	
10515	9	15,5	0,50	48	



Eiswasserröhre
ice cube cooling tube
tubo enfriador para cubitos
tube pour glaçons



	Ø cm	↑ cm	passend für Getränkespender / fits to drink dispenser
10849	11	24	10400, 10403, 10406, 10855





Thermo Tablet-Set, 6-tlg.

thermo tray, 6 pcs.
bandeja térmica, set de 6
plateau thermique, set de 6



6 teiliges Set:

- 1 Schale
- 1 Edelmetalltablett
- 2 Kühlakkus
- 1 transparente Frischhaltehaube
- 1 Transport- und Tragegurt aus Silikon

6 pcs. set:

- 1 plastic tray
- 1 stainless steel tray
- 2 coolers
- 1 transparent cover
- 1 silicone transport and carrying strap

set de 6:

- 1 bandeja de plástico
- 1 bandeja de acero inoxidable
- 2 acumuladores de frío
- 1 campana transparente
- 1 correa de silicona para cierre y transporte

set de 6:

- 1 plateau plastique
- 1 plateau en acier inox
- 2 accumulateurs de froid
- 1 cloche transparente
- 1 sangle en silicone pour fermeture et transport



	cm	↑ cm	Farbe / Colour
09091	43 x 29	14	
09090	43 x 29	14	



inkl. 2x Kühl-Akkus
incl. 2x cooler keeps



Thermo Tablet-Set, 6-tlg.

thermo tray, 6 pcs.
bandeja térmica, set de 6
plateau thermique, set de 6



6 teiliges Set:

- 1 Schale
- 1 Edelmetall-Tablett
- 2 Kühlakkus
- 1 Frischhaltehaube
- 1 Transport- und Tragegurt aus Silikon

6 pcs. set:

- 1 plastic tray
- 1 stainless tray
- 2 coolers + 1 cover
- 1 silicone transport and carrying strap

set de 6:

- 1 bandeja de plástico
- 1 bandeja de acero inoxidable
- 2 acumuladores de frío
- 1 campana
- 1 correa de silicona para cierre y transporte

set de 6:

- 1 plateau plastique
- 1 plateau en acier inox
- 2 accumulateurs de froid
- 1 cloche transparente
- 1 sangle en silicone pour fermeture et transport



	cm	↑ cm	Farbe / Colour
09094	35	15	
09093	35	15	



inkl. 2x Kühl-Akkus
incl. 2x cooler keeps



Weck-Gläser mit Deckel, 12er Set
 Weck-glasses with lid, 12 pcs.
 Weck tarros de vidrio con tapa, set de 12
 Weck verrines avec couvercle, set de 12

12 Gläser + 12 Deckel
 12 glasses + 12 covers
 12 tarros + 12 tapas
 12 verrines + 12 couvercles

	Ø cm	↑ cm	ltr.	pcs
82350	5,5	6	0,075	12

GLAS GLASS



Weck-Gläser mit Deckel, 12er Set
 Weck-glasses with lid, 12 pcs.
 Weck tarros de vidrio con tapa, set de 12
 Weck verrines avec couvercle, set de 12

12 Gläser + 12 Deckel
 12 glasses + 12 covers
 12 tarros + 12 tapas
 12 verrines + 12 couvercles

	Ø cm	↑ cm	ltr.	pcs
82351	5,5	9	0,145	12

GLAS GLASS



Weck-Gläser mit Deckel, 6er Set
 Weck-glasses with lid, 6 pcs.
 Weck tarros de vidrio con tapa, set de 6
 Weck verrines avec couvercle, set de 6

6 Gläser + 6 Deckel
 6 glasses + 6 covers
 6 tarros + 6 tapas
 6 verrines + 6 couvercles

	Ø cm	↑ cm	ltr.	pcs
82352	9	9	0,29	6

GLAS GLASS



Weck-Gläser mit Deckel, 6er Set
 Weck-glasses with lid, 6 pcs.
 Weck tarros de vidrio con tapa, set de 6
 Weck verrines avec couvercle, set de 6

6 Gläser + 6 Deckel
 6 glasses + 6 covers
 6 tarros + 6 tapas
 6 verrines + 6 couvercles

	Ø cm	↑ cm	ltr.	pcs
82354	11	9	0,58	6

GLAS GLASS

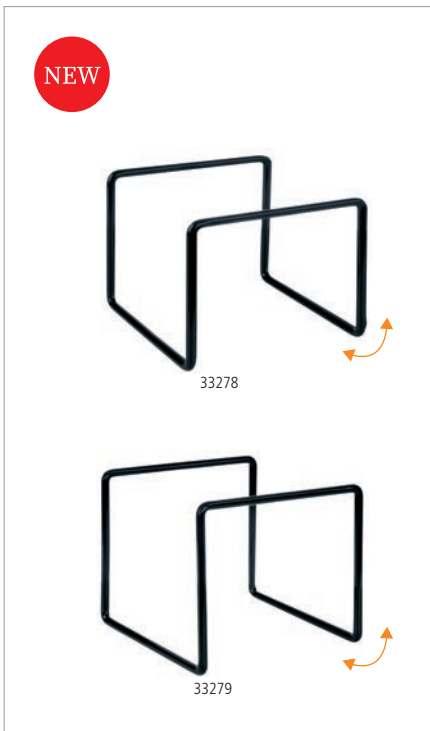

Buffetständer
buffet stand
soporte para buffet
présentoir buffet



Buffetständer aus Metall mit Antirutschbeschichtung
buffet stand made of metal with non-slip coating
soporte para buffet de metal con revestimiento antideslizante
présentoir buffet en métal avec revêtement antidérapant

	cm	↑ cm
33278	11,5 x 11,5	9,0
33279	16,5 x 16,5	14,5



Gläsernschiene
glass rack
rack de copas
rack porte-verres



aus 6 mm Draht, Metall verchromt, Wand- und Deckenmontage möglich
6 mm chrome plated wire, can be mounted under a shelf or on the wall
alambre cromado de 6 mm, puede instalarse bajo una estantería o en la pared
fil chromé de 6 mm, à installer sous une étagère ou contre un mur

	cm	↑ cm	for glasses	Farbe / Colour
93398 <small>NEW</small>	29,5 x 32	6	12	—
93399 <small>NEW</small>	29,5 x 32	6	12	—
93400	45,0 x 32	6	20	—



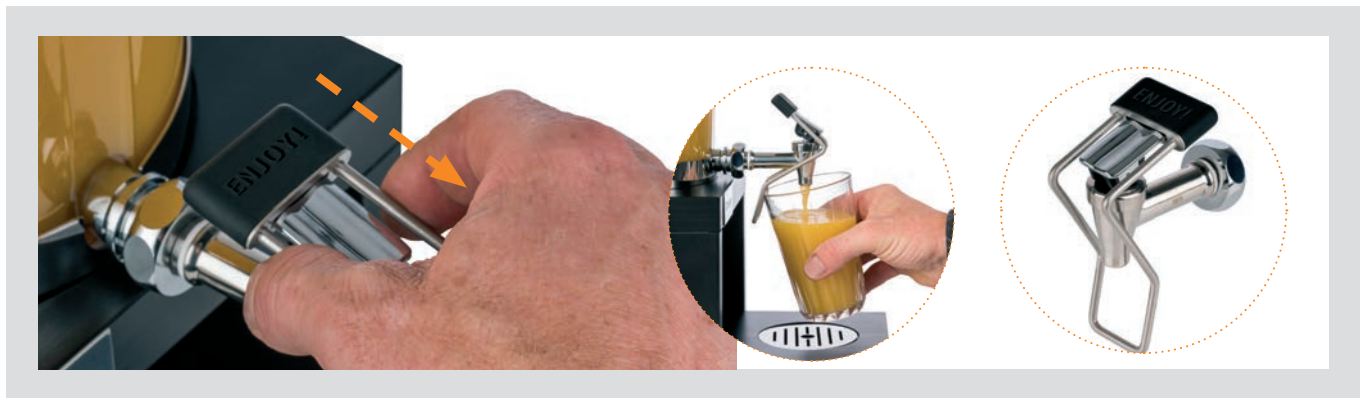

Der Adapter passt auf alle Dispenser der Serien TOP FRESH, BRIDGE und SUNDAY und kann ganz einfach installiert werden

The adapter fits all dispensers of the series TOP FRESH, BRIDGE and SUNDAY and can be installed very easily.

El adaptador se adapta a todos los dispensadores de las series TOP FRESH, BRIDGE y SUNDAY y puede ser instalado fácilmente.

L'adaptateur s'adapte à tous les distributeurs des séries TOP FRESH, BRIDGE et SUNDAY et peut être installé très facilement.



Adapter „TOP FRESH“

adapter
adaptador
adaptateur



handkontaktloser Adapter, einfach zu installieren
adapter touchless for tap, easy to install
adaptador sin contacto para grifo
adaptateur sans contact manuel, facile à installer

	cm	↑ cm
10802	12 x 4,5	5,5



Einfach den Adapter an der dafür vorgesehenen Öffnung auf den Hebel des Zapfhahns stecken.
Simply plug the adapter onto the lever of the tap at the opening provided.

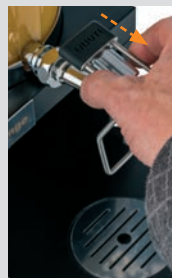

Anschließend den Adapter nach unten festziehen. Durch das Nach-Vorne-Drücken des unteren Edelstahlbügels mit Hilfe des Glases, wird der Hebel des Zapfhahns betätigt und das Getränk fließt völlig handkontaktlos in das Glas.
Then tighten the adapter downwards. By pushing the lower stainless steel bracket forward with the help of the glass, the lever of the tap is activated and the drink flows into the glass completely without hand contact.

passend für / suitable for:



Saftdispenser „TOP FRESH“
Katalog Seite 95
juice dispenser,
catalog page 95



Milchkanne „TOP FRESH“
Katalog Seite 99
milk dispenserr,
catalog page 99



Saftdispenser „BRIDGE“
Katalog Seite 99
juice dispenserr,
catalog page 99



Berührungslose Handdesinfektion!
touchless hand disinfection!

**Informations-
tafel als
Wendeschild**
Information board
as a turning sign

Wandversion
wall version

Tischversion
table version

**Nicht im Lieferumfang:
Batterien und Desinfektionsmittel**
Not included: batteries and disinfectant

Desinfektionsständer „SPRAY“

disinfection stand
estación de desinfección
stand de désinfection



Desinfektionsständer für das kontaktlose Desinfizieren der Hände
inkl. Informationstafel / Fuß aus schwarzem Metall - standsicher (10 kg)

disinfection stand for contactless disinfection of hands incl. information board /
heavy stand are made of black metal – very stable (10 kg)

estación de desinfección para la desinfección de las manos sin contacto con letrero de
información / pie de metal negro - estable (10 kg)

stand de désinfection pour la désinfection des mains sans contact y compris panneau
d'information / socle en métal noir - stable (10 kg)

	Ø cm	↑ cm	ltr.
98250	32	163	1,0



Desinfektionsspender „Tischständer“

2 tlg. Set:
• 1 Stk. Desinfektionsspender (no. 98255)
• 1 Stk. Tischständer aus Edelstahl mattiert

Desinfektionsspender „SPRAY“

disinfectant dispenser
dispensador de desinfectante
distributeur de désinfectant



Desinfektionsspender für das kontaktlose Desinfizieren der Hände für die Wandmontage,
Inhalt ca. 1 Liter, für 6 Stk. Batterien Typ AA (LR6 / 1,5v)

disinfectant dispenser for contactless disinfection of hands for wall mounting
content approx. 1 liter, for 6 batteries type AA (LR6 / 1,5v)

dispensador de desinfectante para la desinfección sin contacto de las manos, para el montaje en
la pared, capacidad aproximada de 1 litro, para 6 pilas tipo AA (LR6 / 1,5v)

distributeur de désinfectant pour la désinfection sans contact des mains, pour montage mural,
capacité d'environ 1 litre, pour 6 piles de type AA (LR6 / 1,5v)

	cm	↑ cm	ltr.
98255	13,5 x 12,5	26	1,0
98260	13,5 x 16,0	47	1,0



Hygieneschutz



Öffnung 25 x 12 cm

98002 Acryl 3 mm

Die Hygieneschutzwand kann auf der Theke, dem Schreibtisch, dem Tresen oder an der Kasse aufgestellt werden.

The hygiene protection wall can be placed on the counter, the desk, or at the cash desk.

El protector higiénico puede colocarse en el mostrador, en el escritorio o en la caja.

La vitre de protection hygiénique peut être placée sur le comptoir, la réception ou à la caisse.



Hygieneschutzwand

sneeze guard
protector higiénico
pare-haleine



Hygieneschutzwand mit Öffnung

sneeze guard with opening
protector higiénico con apertura
pare-haleine avec ouverture

	cm	↑ cm	Öffnung cm / opening cm	✱ mm
98000	60 x 28	98	25 x 12	3

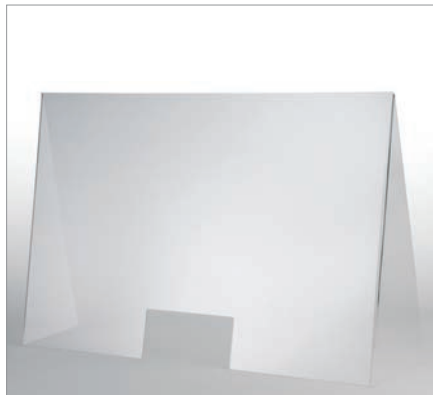

Hygieneschutzwand

sneeze guard
protector higiénico
pare-haleine



Hygieneschutzwand mit Öffnung

sneeze guard with opening
protector higiénico con apertura
pare-haleine avec ouverture

	cm	↑ cm	Öffnung cm / opening cm	✱ mm
98001	98 x 28	65	25 x 12	3

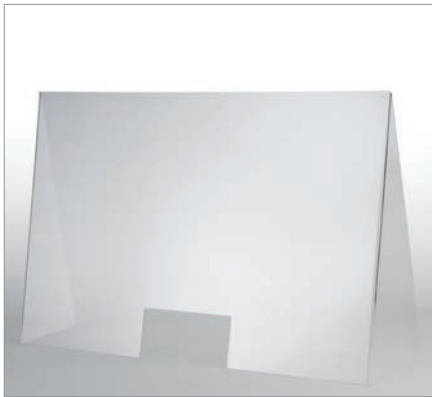

Hygieneschutzwand
sneeze guard
protector higiénico
pare-haleine



Hygieneschutzwand mit Öffnung
sneeze guard with opening
protector higiénico con apertura
pare-haleine avec ouverture

	cm	↑ cm	Öffnung cm / opening cm	✂ mm	
98002	75 x 18	48	25 x 12	3	



Hygieneschutzwand
sneeze guard
protector higiénico
pare-haleine



Hygieneschutzwand ohne Öffnung
sneeze guard without opening
protector higiénico sin apertura
pare-haleine sans ouverture

	cm	↑ cm	✂ mm	
98003	75 x 18	48	3	

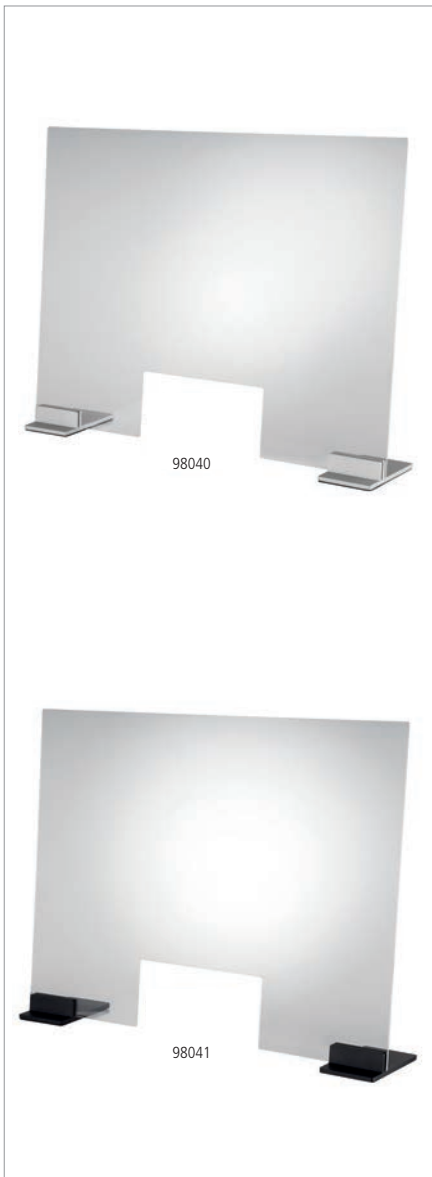

Hygieneschutzwand
sneeze guard
protector higiénico
pare-haleine



Hygieneschutzwand mit Öffnung
sneeze guard with opening
protector higiénico con apertura
pare-haleine avec ouverture

	cm	↑ cm	Öffnung cm / opening cm	✂ mm	Fuß / base
98040	75 x 16,5	57	26 x 13	5	silber matt/ silver matt
98041	75 x 16,5	57	26 x 13	5	schwarz matt/ black matt

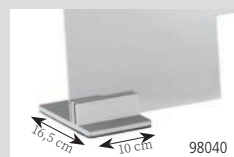

Fuß silber matt
base silver matt



Möbelschonende Unterseite
non-scratching undersurface



mit jeweils zwei Schrauben
leicht montierbar
easy mountable with two screws



Hygieneschutzwand
sneeze guard
protector higiénico
pare-haleine



Hygieneschutzwand ohne Öffnung
sneeze guard without opening
protector higiénico sin apertura
pare-haleine sans ouverture

	cm	↑ cm	* mm	Fuß / base
98042	75 x 16,5	57	5	silber matt/ silver matt
98043	75 x 16,5	57	5	schwarz matt/ black matt



Die Acrylglas-Platte kann sowohl hoch- oder längskant in den Fuß gestellt werden!
The acrylic glass panel can be placed in the base in up-right or longitudinal position!

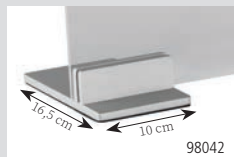

Fuß silber matt
base silver matt



Möbelschonende Unterseite
non-scratching undersurface



Leicht montierbar
easy mountable

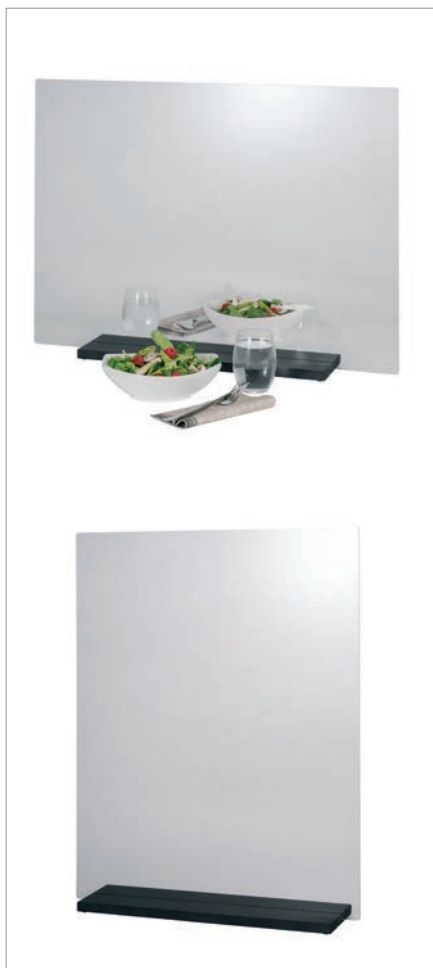

Hygieneschutzwand „TABLE“
sneeze guard
protector higiénico
pare-haleine



Hygieneschutzwand ohne Öffnung
sneeze guard without opening
protector higiénico sin apertura
pare-haleine sans ouverture



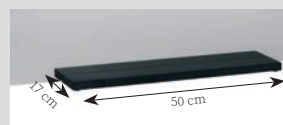

















	cm	↑ cm	* mm	Fuß / base
98015	75 x 17	57	5	Wenge / wenge



Fuß aus Wenge
base made of wenge

Die Acrylglas-Platte kann sowohl hoch- oder längskant in den Fuß gestellt werden!
The acrylic glass panel can be placed in the base in up-right or longitudinal position!

Icon-Index / Material-Index

 neuer Artikel new item	 spülmaschinengeeignet dishwasher-proof	 für Induktionsplatten for induction use
 Code of Conduct	 nicht spülmaschinengeeignet not dishwasher-proof	 kühlbar for cooling
 Made in Germany	 abwaschbar / wasserfest water-proof	 bruchsicher shatter-proof
 GN-Größen GN norm	 mikrowellengeeignet microwave-proof	 Eigenmontage self assembly
 stapelbar stackable	 nicht mikrowellengeeignet not microwave-proof	 für Lebensmittelkontakt food safe
 Antirutsch-Füßchen non-slip feet	 keine direkte Hitze not direct heat	 recyclbar recyclable
 wasserfest water-resistant	 nicht für Backofen not for baking oven	 BPA frei BPA free

APS - BSCI-Mitglied

APS engagiert sich für die Verbesserung von Arbeitsbedingungen. Wir sind Partner der europäischen Organisation BSCI. Die "Business Social Compliance Initiative" (BSCI) ist eine Initiative von Unternehmen zur Verbesserung der Arbeitsbedingungen in der globalen Versorgungskette.

APS is a member of BSCI

APS is committed to the improvement of working conditions. We are a partner of the European organization BSCI. The "Business Social Compliance Initiative" is an initiative of enterprises to improve working conditions in the global supply chain.



APS CODE OF CONDUCT:

- environmentally friendly production
- environmentally friendly packaging
- fair trade
- recyclable

APS Melamin - Garantierte Qualität

APS-Melaminprodukte entsprechen den Richtlinien (EG) 1935/2004 und (EU) 10/2011 der Europäischen Kommission. Diese enthalten Bestimmungen für Materialien aus Kunststoffen, welche mit Lebensmitteln in Berührung kommen. Wir arbeiten sehr eng mit den Zertifizierungsinstitutionen Intertek und TÜV zusammen und können somit die Lebensmittelsicherheit (LFGB Regulation) der APS-Melaminartikel garantieren.

APS Melamine - Guaranteed quality

APS melamine products comply with directives (EG) 1935/2004 and (EU) 10/2011 of the European Commission. This contain provisions for plastic materials which come into contact with foodstuffs. We work very closely together with the certification institutions Intertek and TÜV and are therefore able to guarantee the compatibility with foodstuffs (German LFGB regulation) of APS melamine.

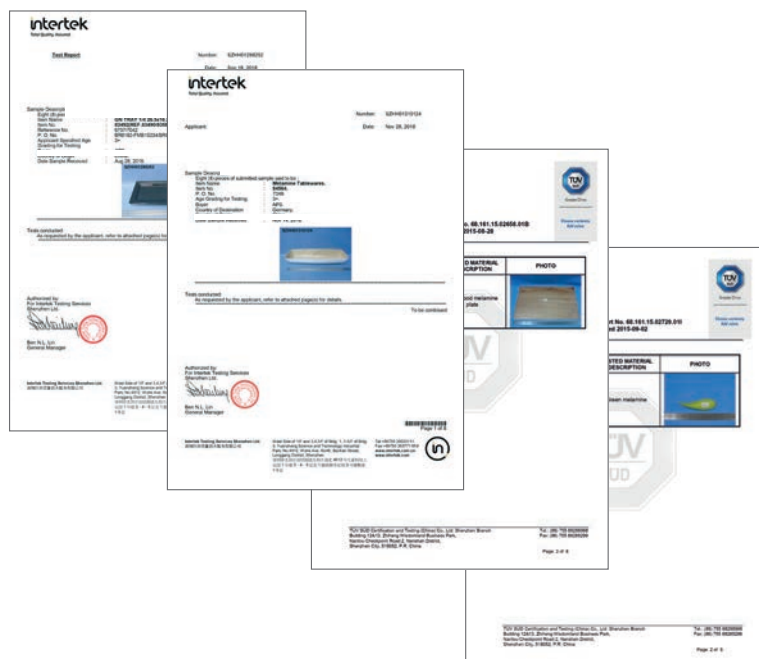



KEN STORKØKKEN A/S

Aarhus
Runetoften 15-17
8210 Aarhus V

København
Vallensbækvej 47
2605 Brøndby

CVR.: 20218428
kenstorkoekken@kenstorkoekken.dk
86 24 84 00

www.kenstorkoekken.dk €